

ANTILOP

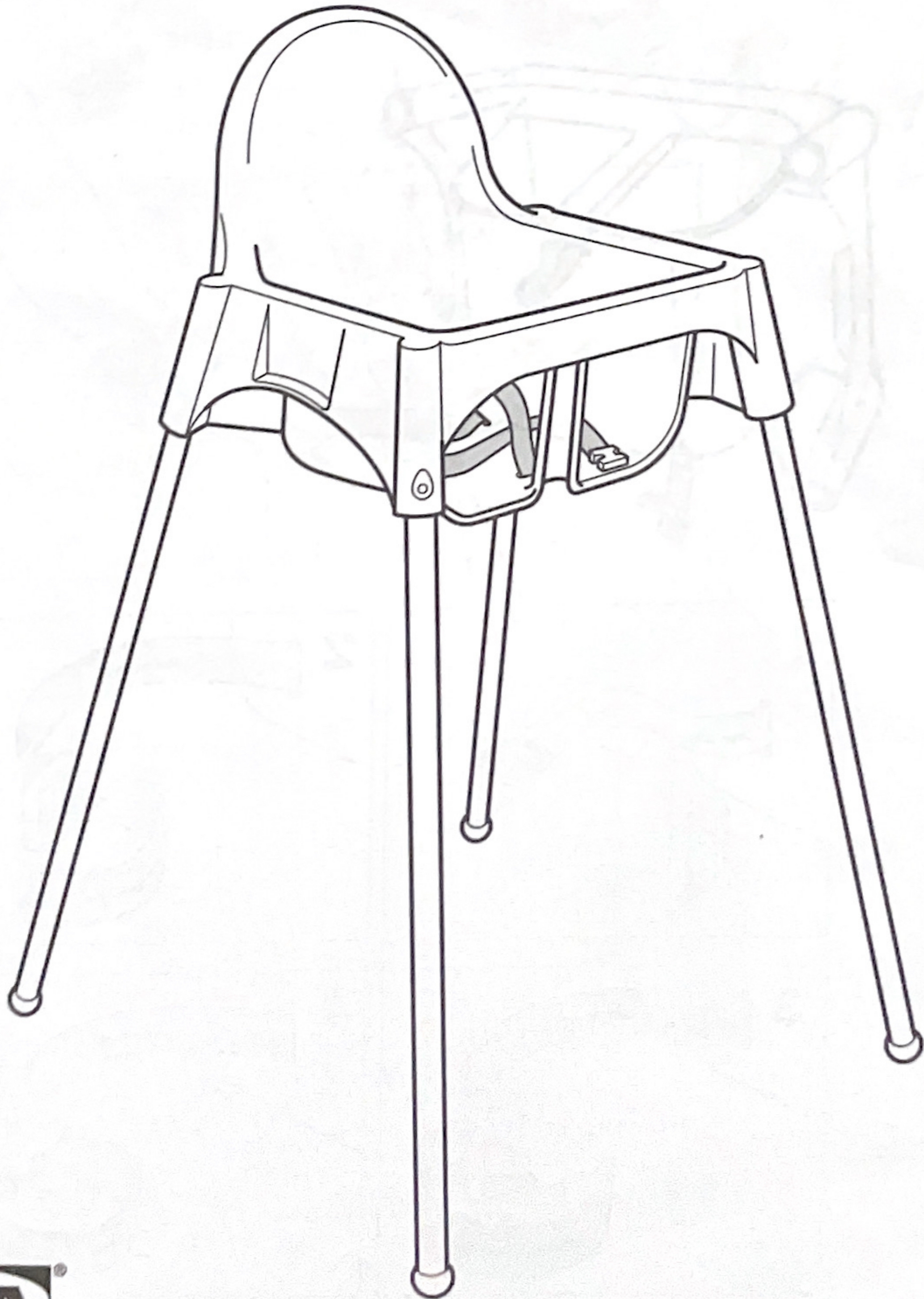

Design and Quality
IKEA of Sweden

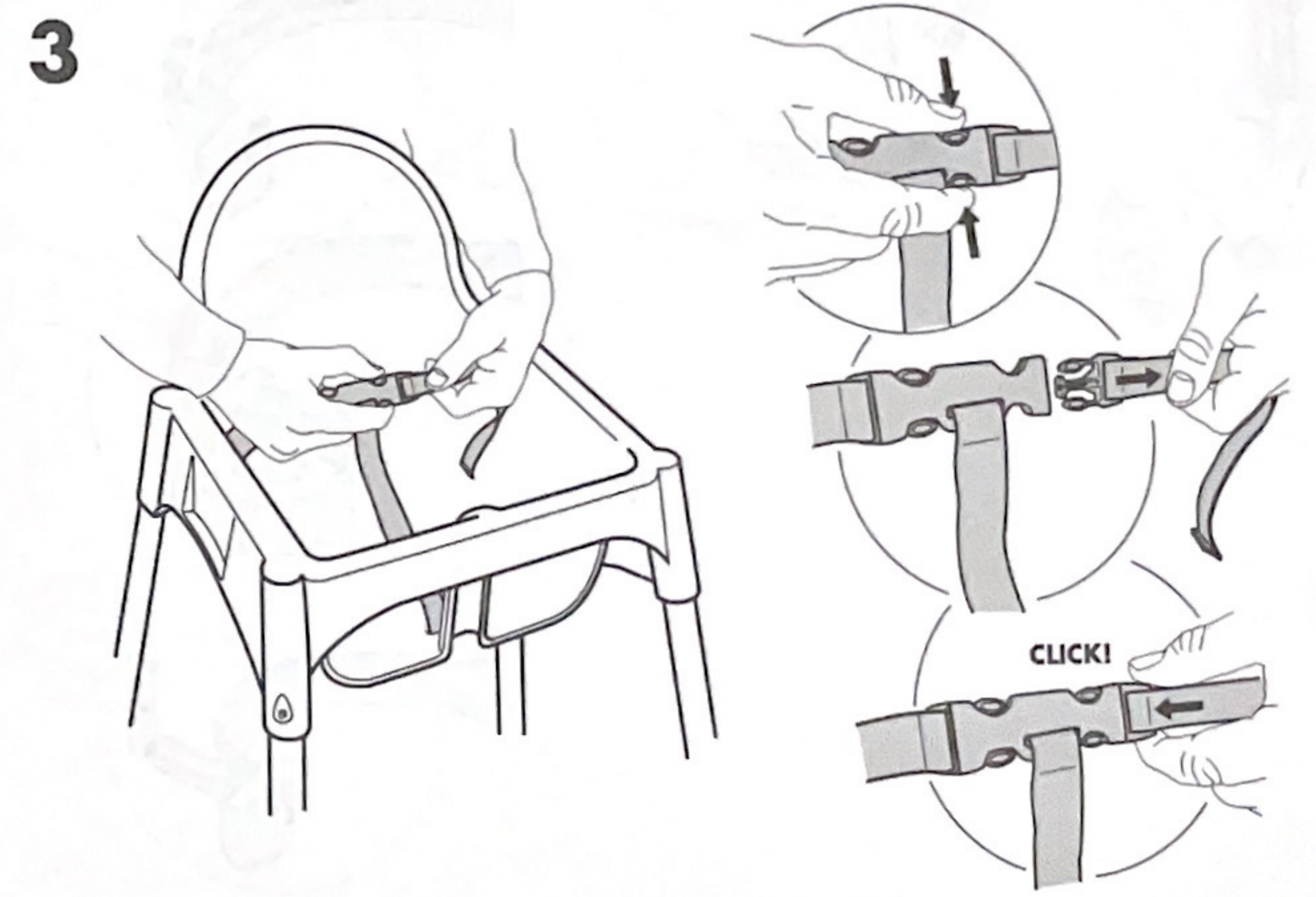

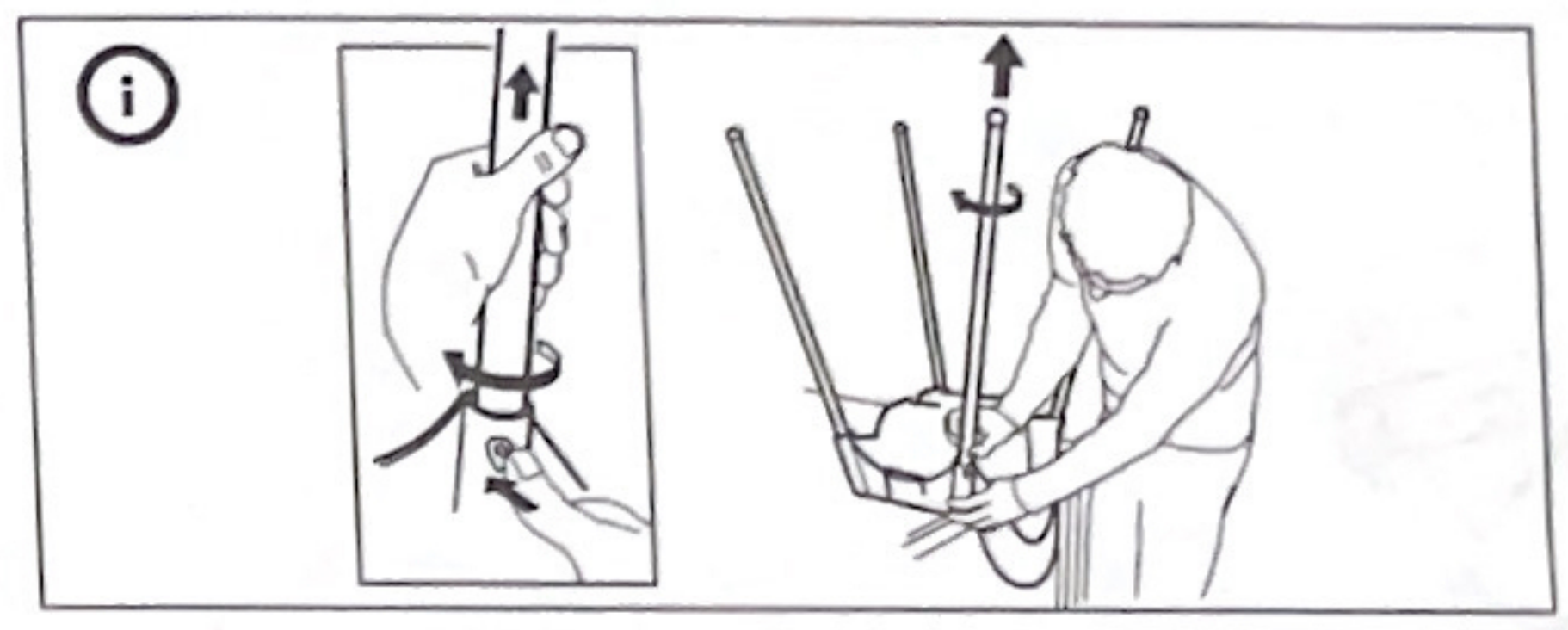
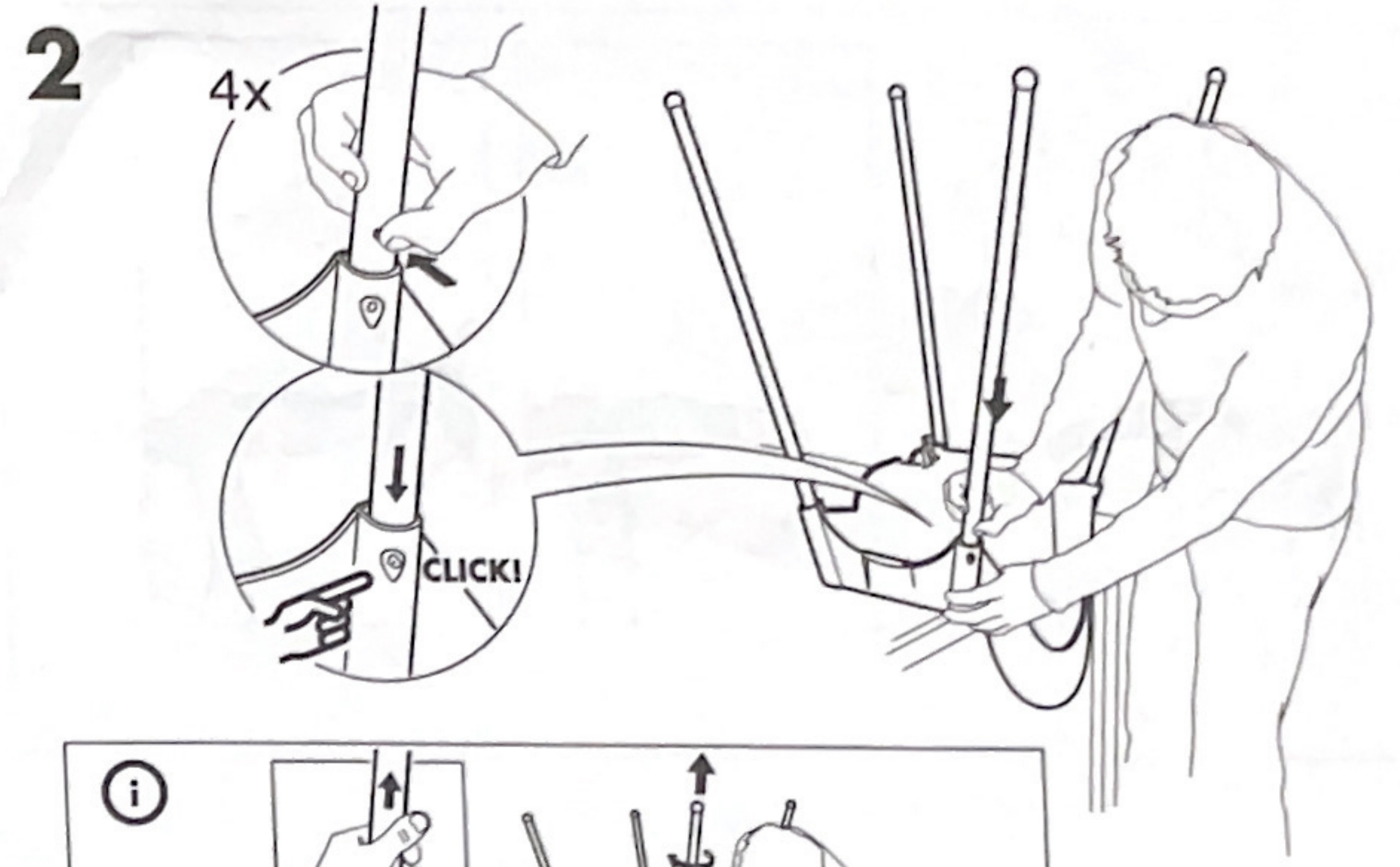
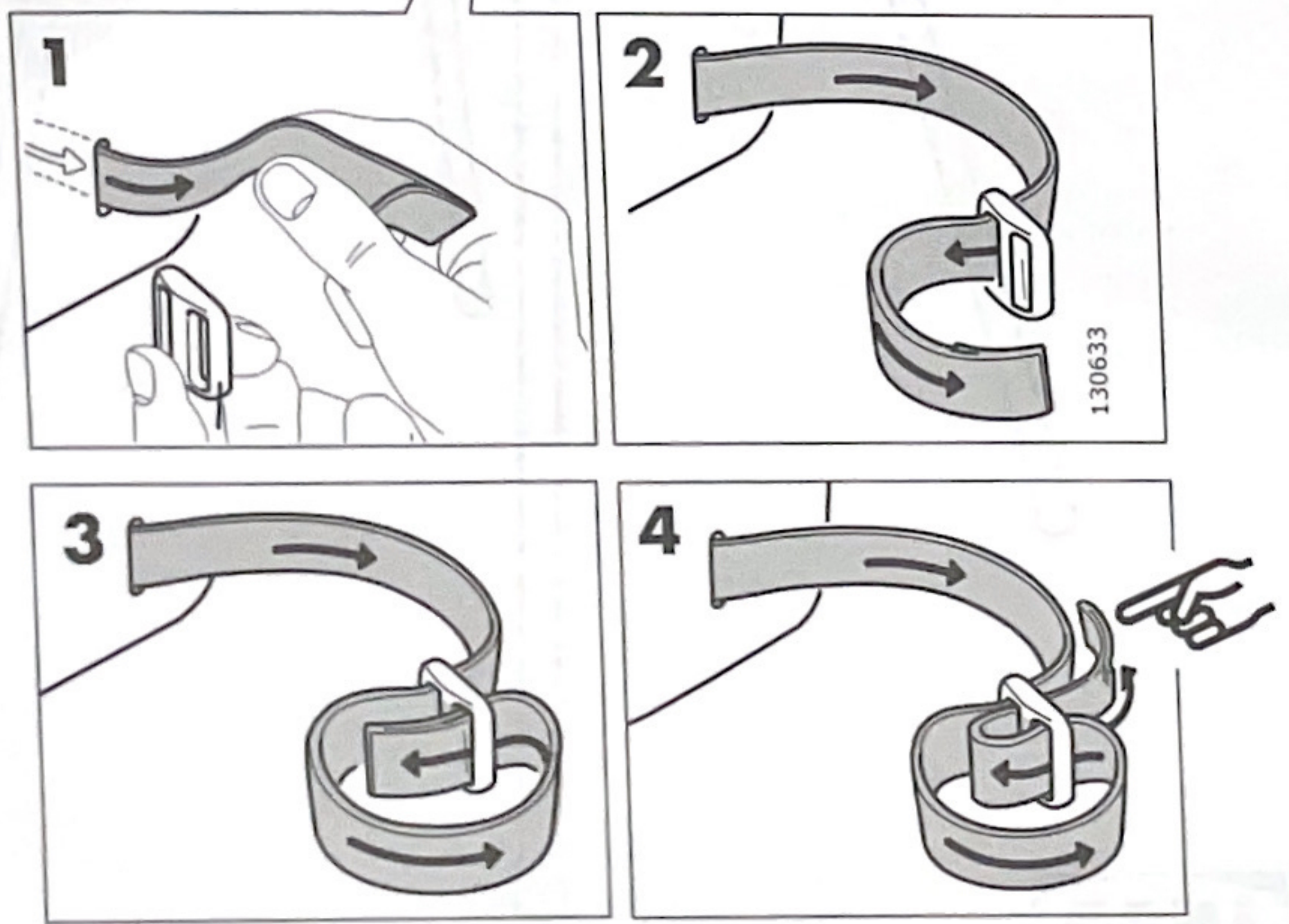
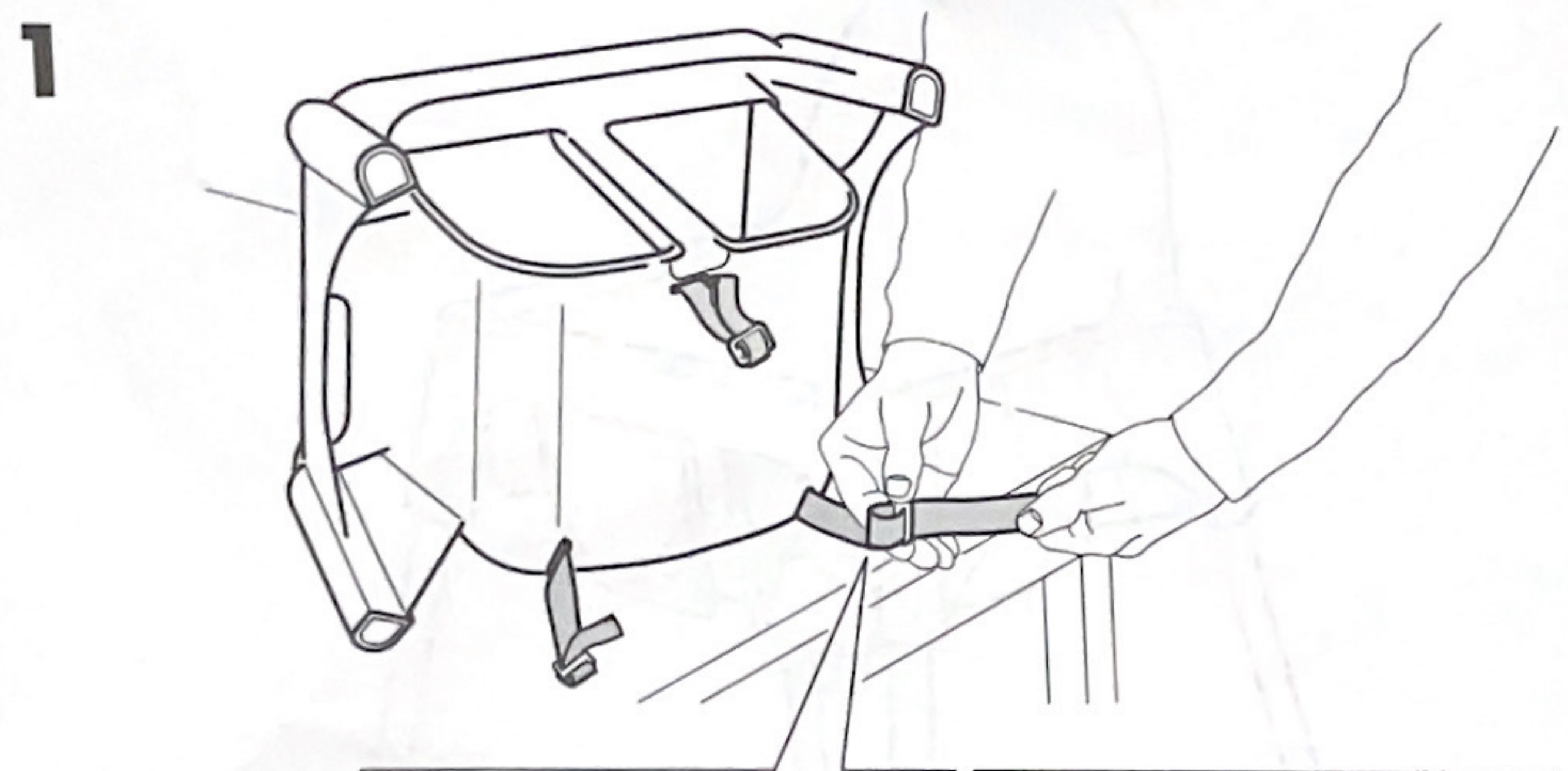
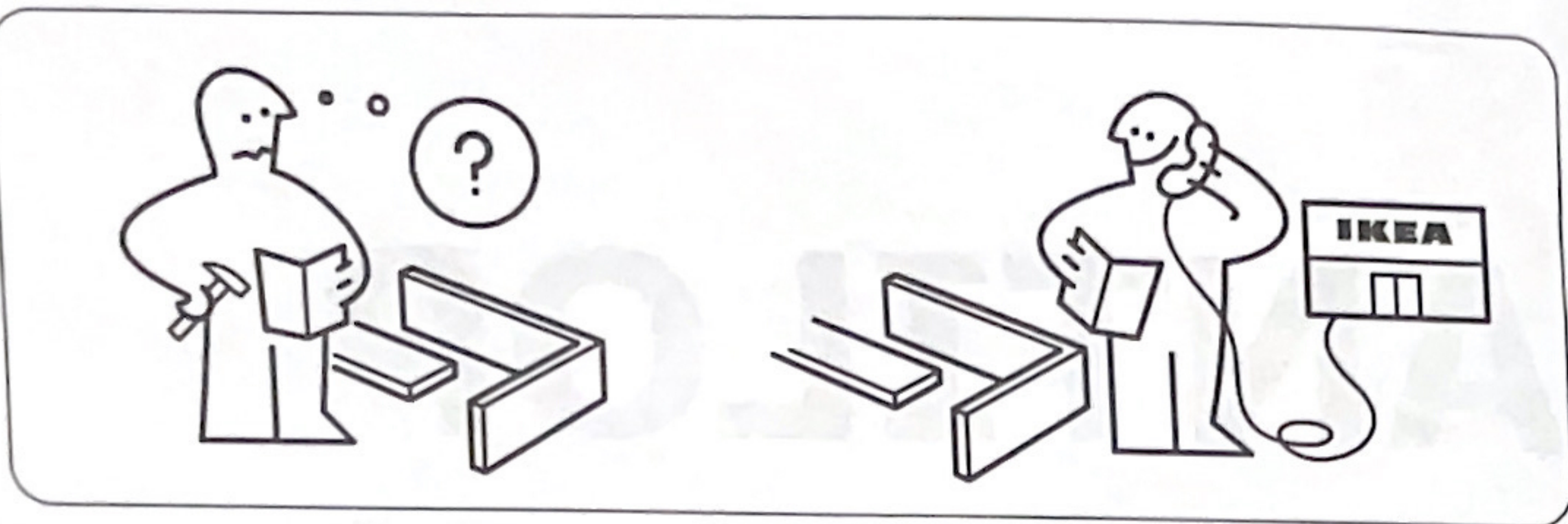
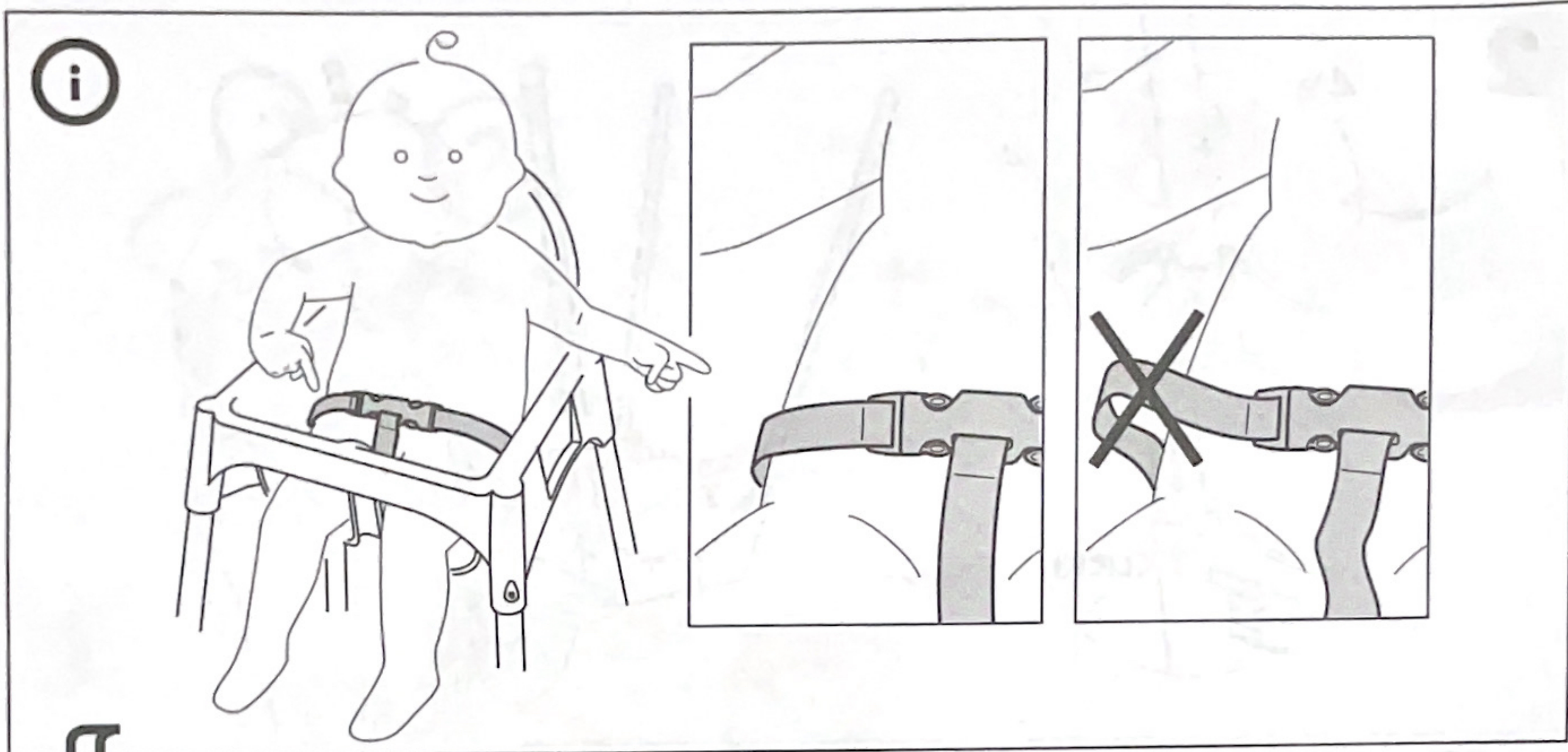

3

